

prehistoric

M A R I Z A G A L A N I

L I G H T G E O M E T R Y



prehistoric

MOUNTING INSTRUCTIONS



Handcrafted in Greece

Brings a primitive energy to today's lighting. Its shape of an upside pyramid creating a powerful torch, leads the light upwards. An essence of existence and calmness radiates in the space. Handcrafted with travertine, can also be available in other marbles.

prehistoric
mounting instructions
for 240V



PARTS INCLUDED

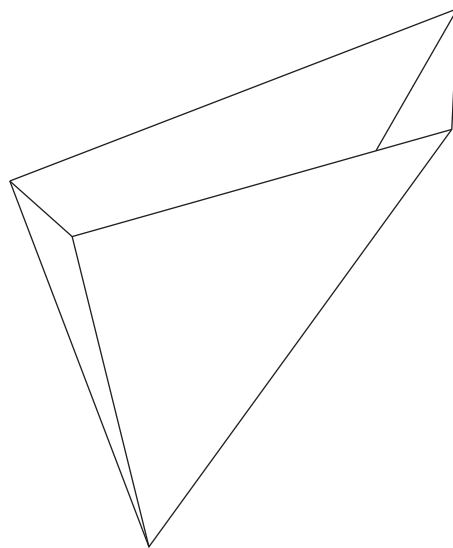

1x

Installation
must be performed
by a **qualified electrician**.

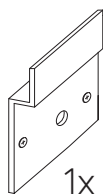

1x



2x



2x

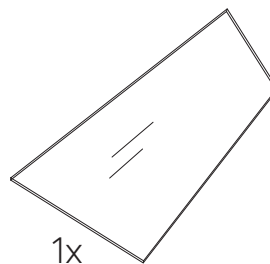

1x

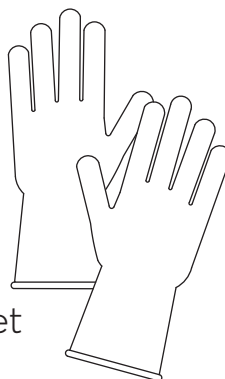

1x set

prehistoric
mounting instructions
for 240V



1.
Fasten the fixing bracket
on the wall.

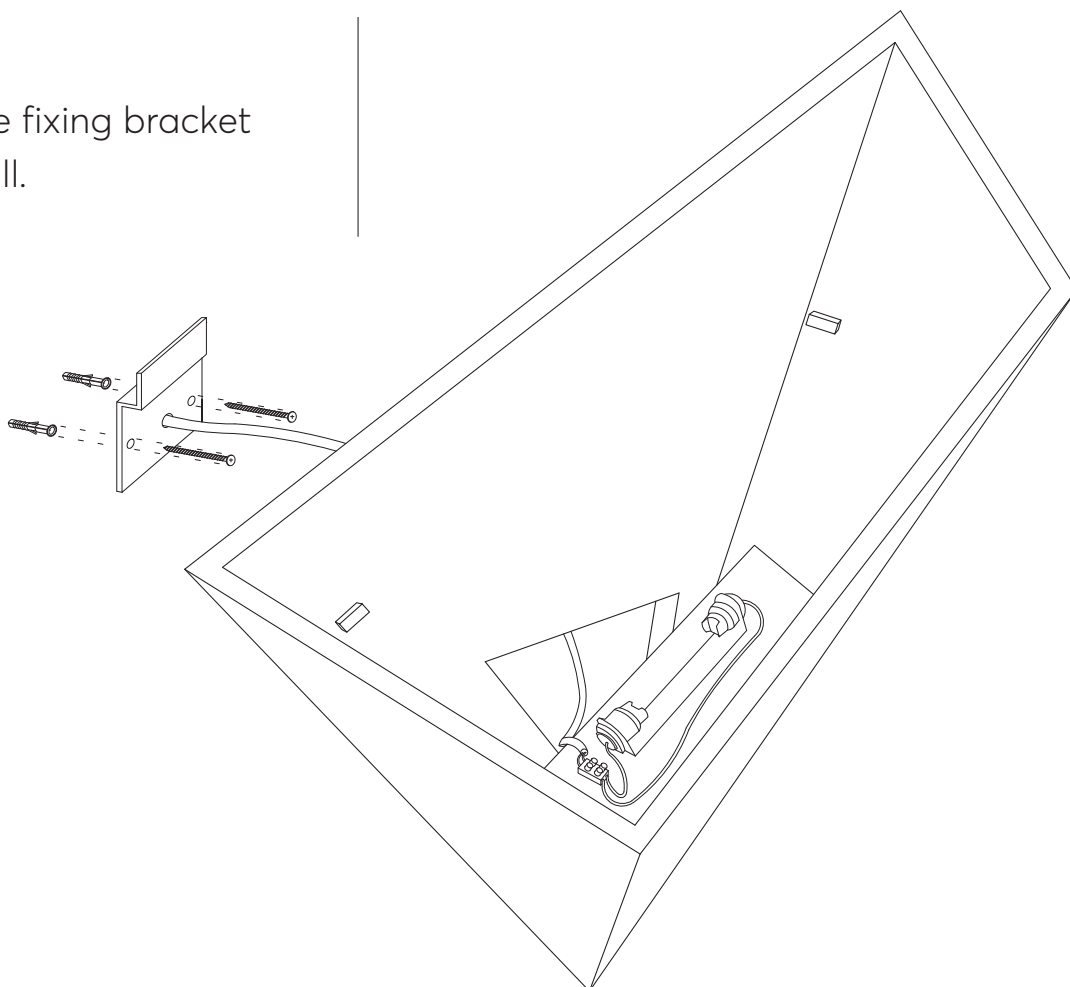

prehistoric
mounting instructions
for 240V

2.

Hang the ceramic housing
on the bracket and place
an R7s lamp of your choice.

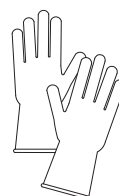
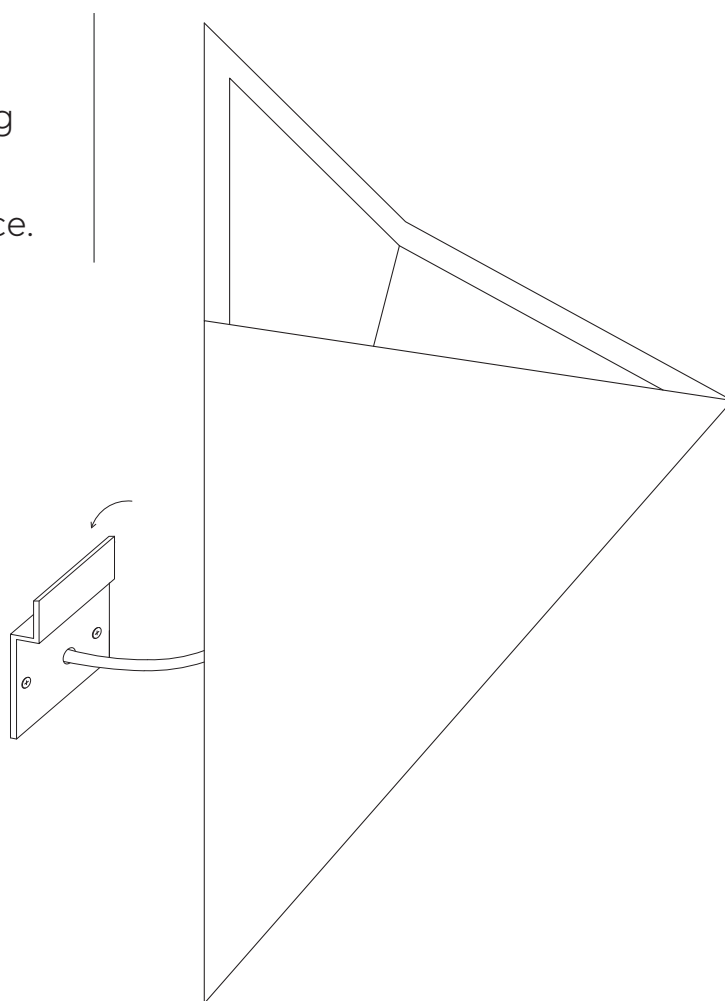

prehistoric
mounting instructions
for 240V



3.

Place carefully the glass in the fixture until it comes across with the small travertine blocks.

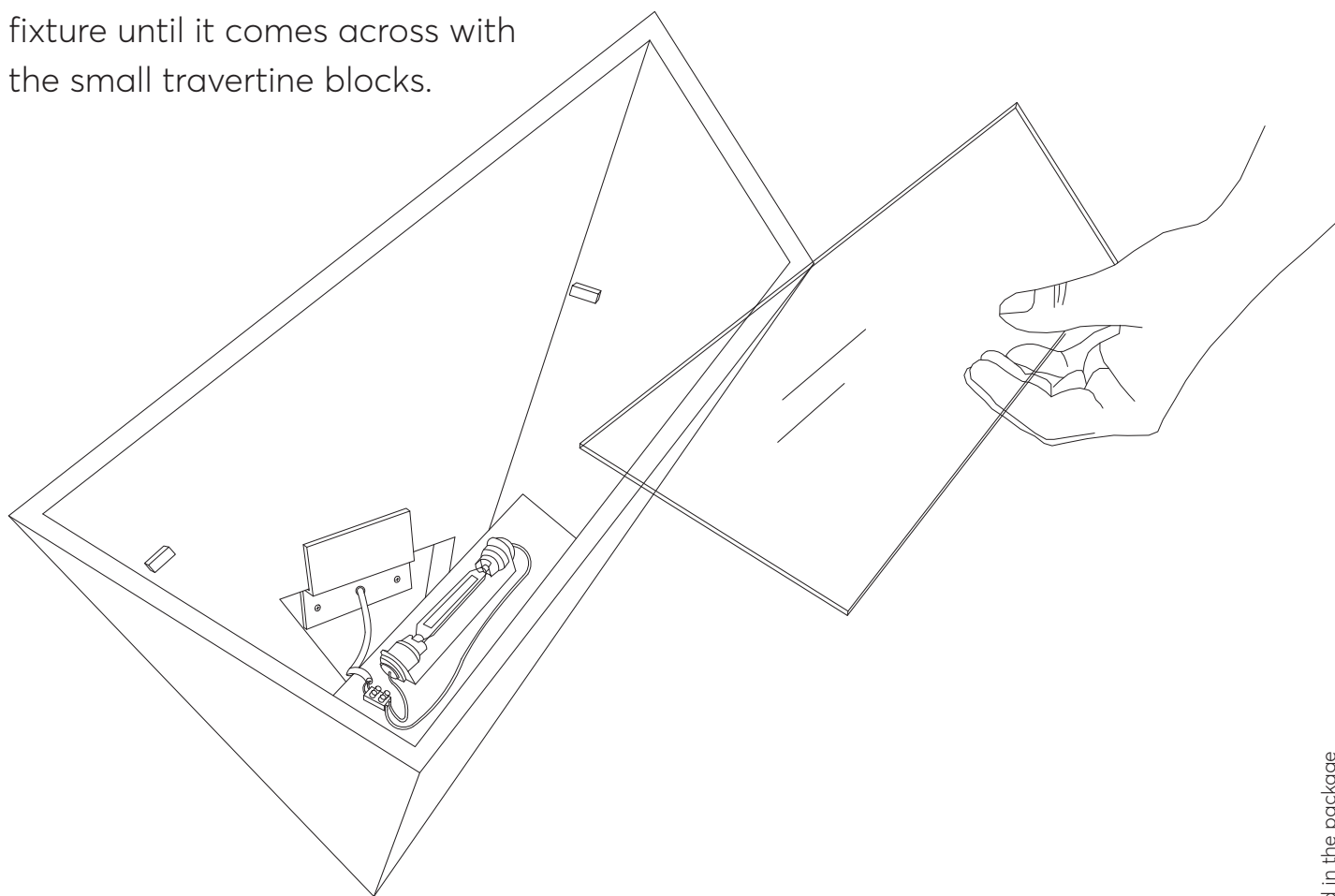

prehistoric
mounting instructions
for 120V



PARTS INCLUDED

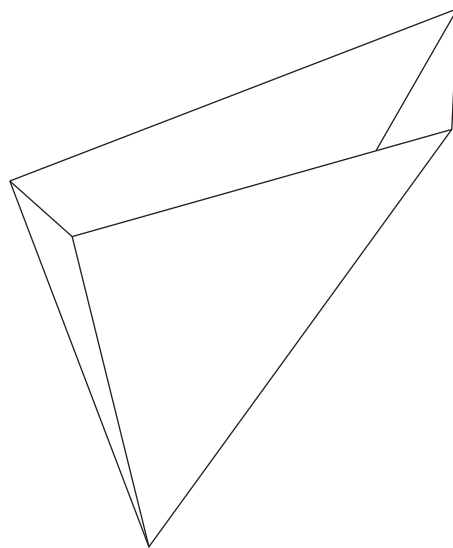

1x

Installation
must be performed
by a **qualified electrician**.

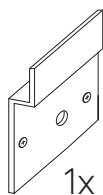

1x



2x



2x

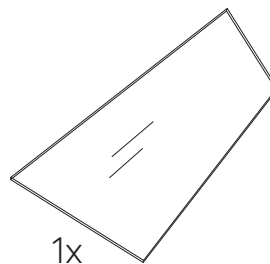

1x

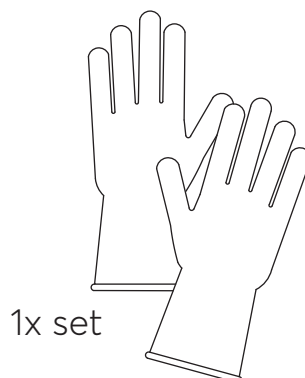

1x set

prehistoric mounting instructions for 120V



1.
Fasten the fixing bracket
on the wall.

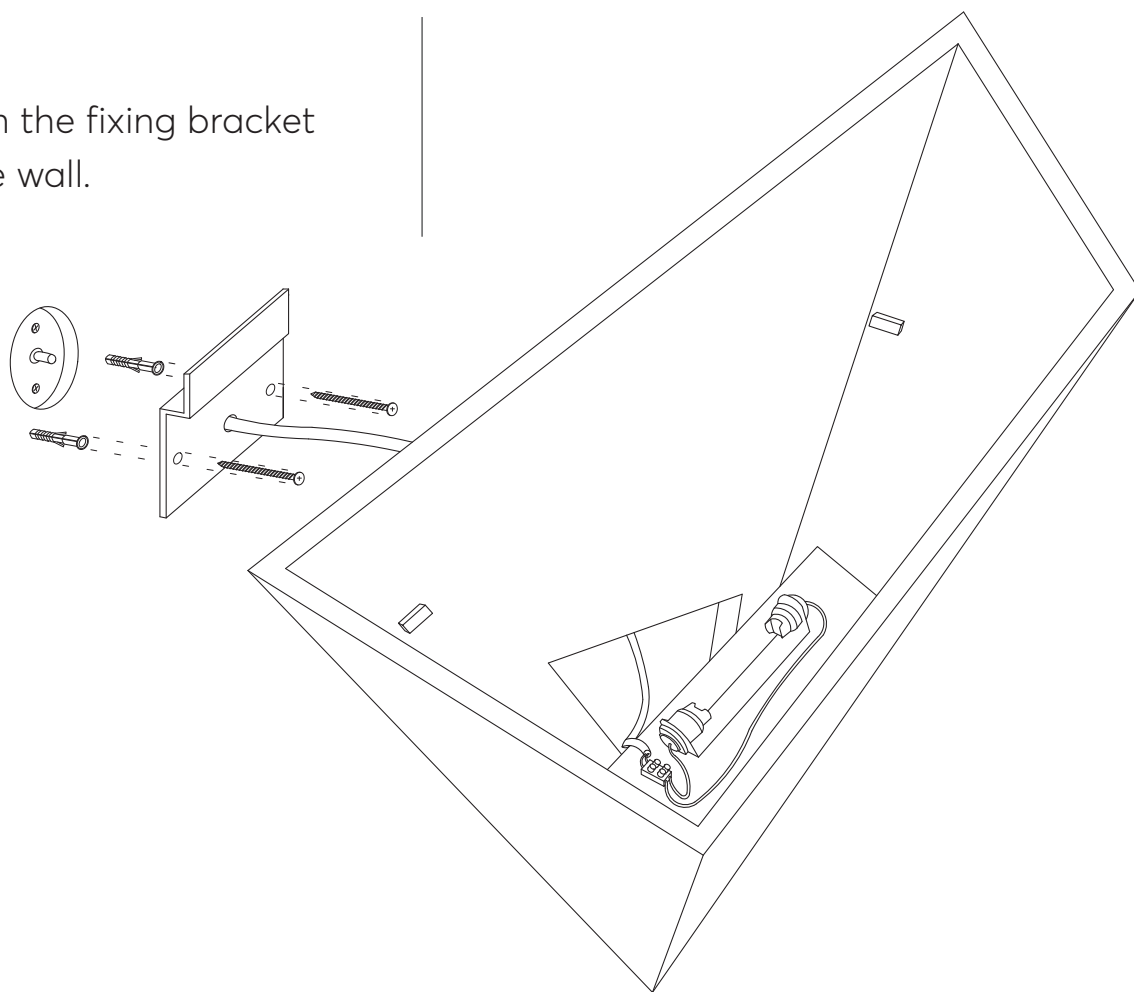

prehistoric
mounting instructions
for 120V

2.

Hang the ceramic housing
on the bracket and place
a R7s lamp of your choice.

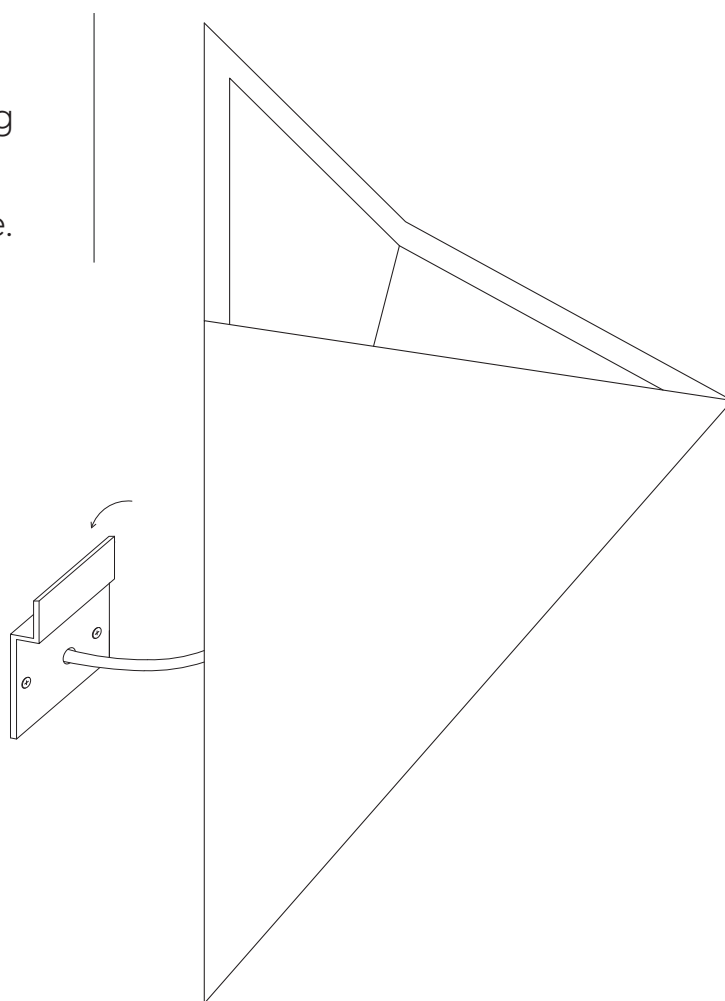

prehistoric
mounting instructions
for 120V



3.

Place carefully the glass in the fixture until it comes across with the small travertine blocks.

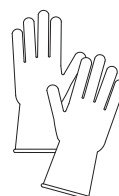
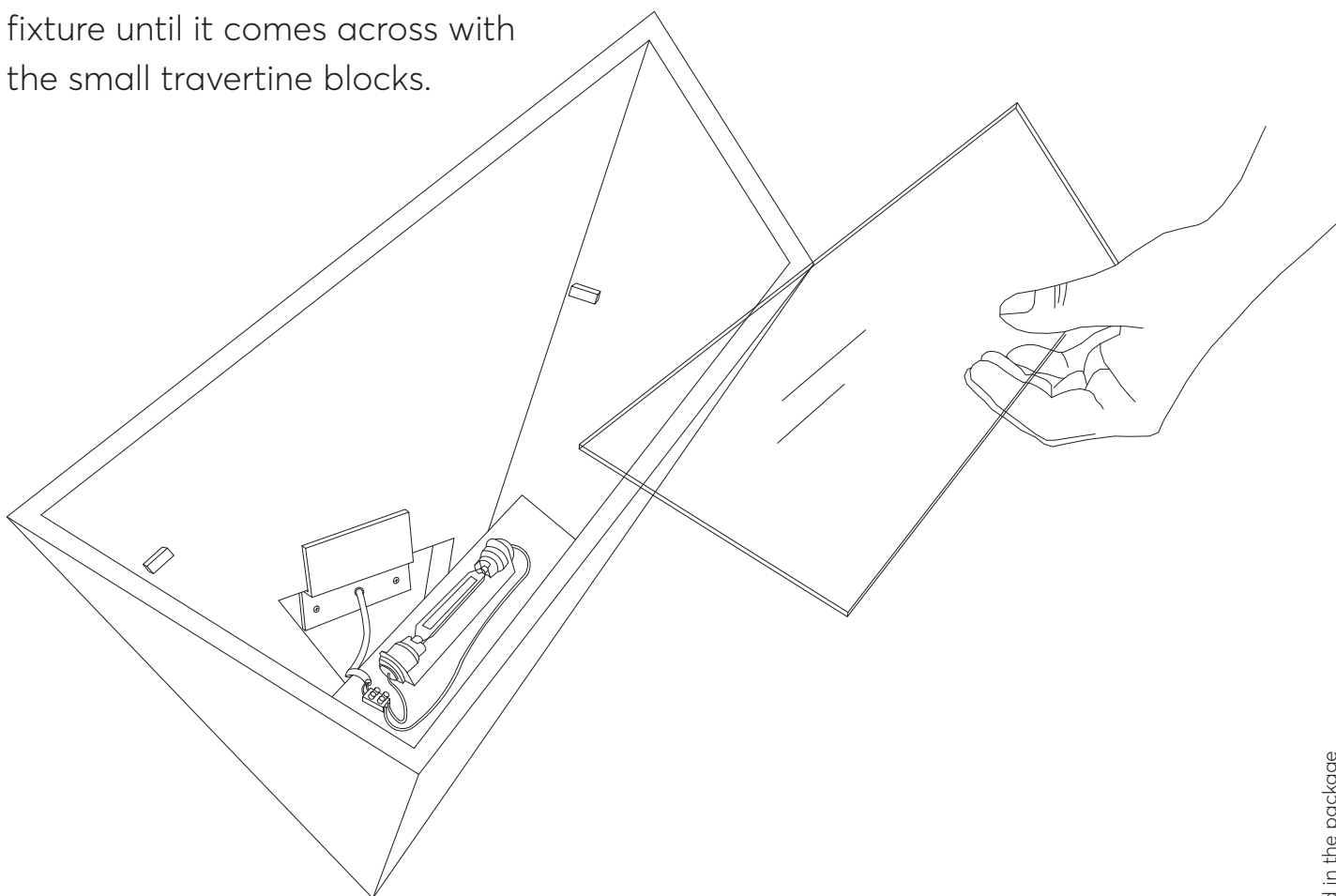

Handcrafted in Greece

MARIZA GALANI

LIGHT GEOMETRY

Mariza Galani, inspired by her Greek roots, creates symbolic lighting elements based on geometry and nature that guide people to experience the sense of wholeness and spiritual uplift. Her goal is to generate lightness and not just light through her creations. All of our fixtures are handcrafted in Greece. Each

piece is unique and every effort is made to ensure that the final creation will match the product specifications. Slight differences in dimensions, finishes and colors though may be expected and are considered as part of each fixture's uniqueness. All designs are protected under copyright law.

Mariza Galani
Armonias 6, Athens 19004
sales@marizagalani.com

©2024 Mariza Galani.
All rights reserved.

www.marizagalani.com

