

empyrean

M A R I Z A G A L A N I

L I G H T G E O M E T R Y



empyrean

# MOUNTING INSTRUCTIONS



*Handcrafted in Greece*

A combination of forms create a clean-cut, unfussy outdoor wall sconce. Shy and beautiful in its simplicity sheds light in any pathway. Handcrafted of granular stoneware creating a rough texture, it is available in off-white or black color.

empyrean  
mounting instructions  
for 240V



# PARTS INCLUDED

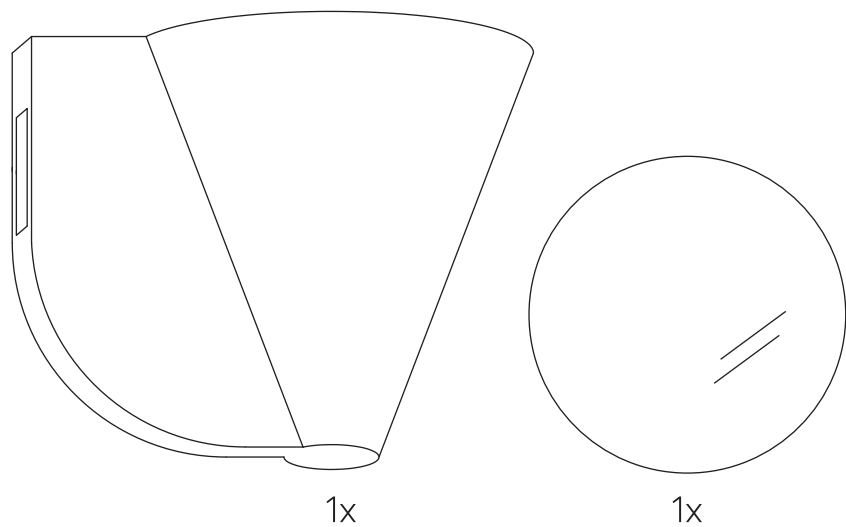

Installation  
must be performed  
by a qualified person.

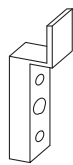

1x



2x



2x

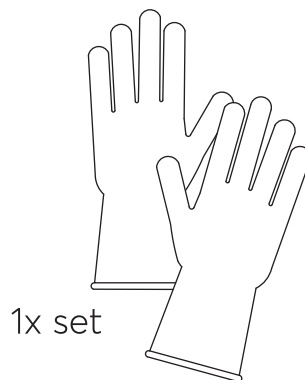

1x set

# empyrean mounting instructions for 240V

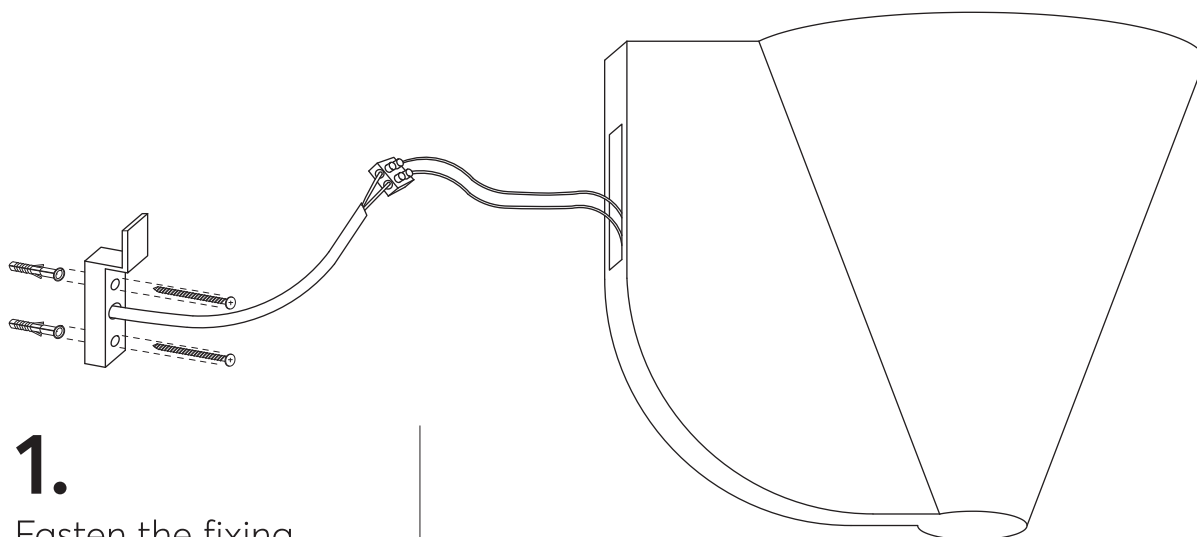

**1.**  
Fasten the fixing  
bracket on the wall.

**2.**  
Hang the ceramic  
housing on the  
bracket and place  
an E27 bulb of your  
choice.

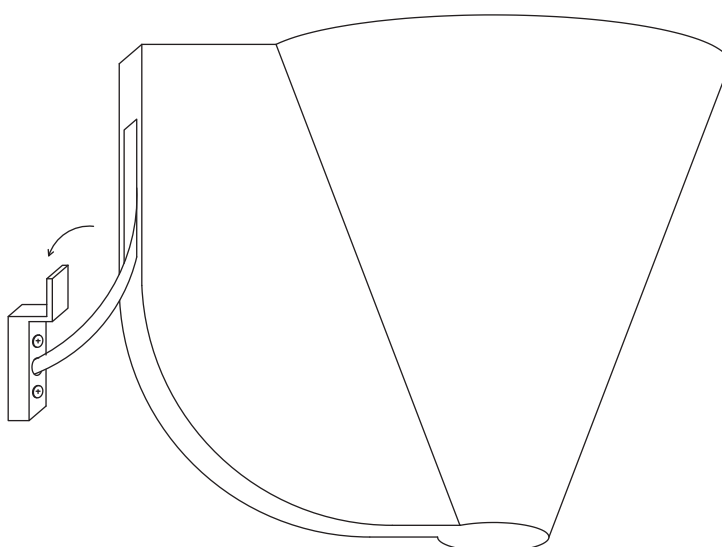

empyrean  
mounting instructions  
for 240V



**3.**

Place carefully the round glass  
on the luminaire.

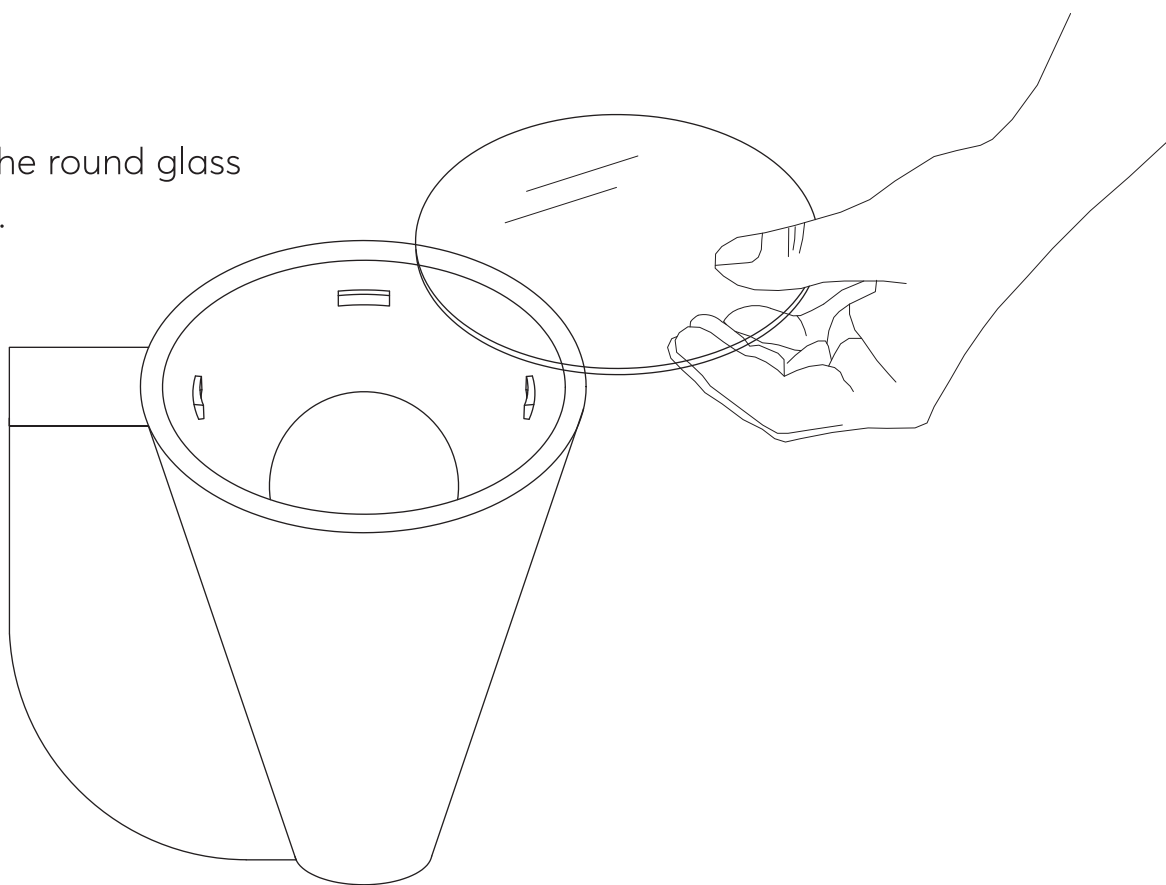

empyrean  
mounting instructions  
for 120V



# PARTS INCLUDED

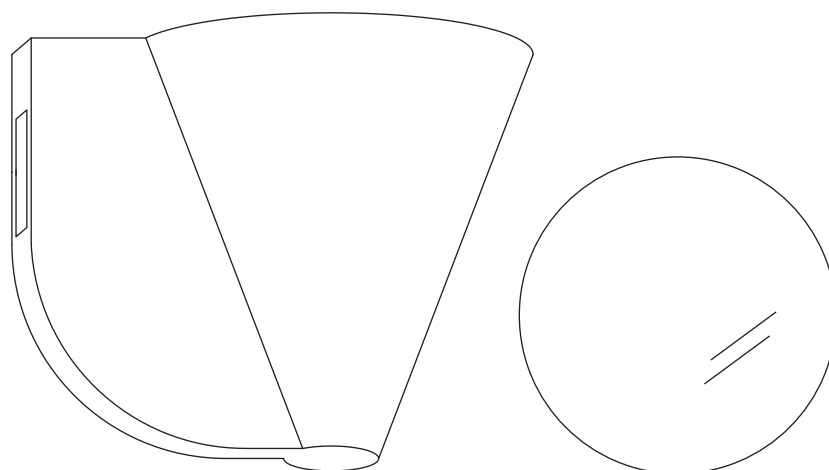

1x

1x

Universal plate  
suitable for 4" (inches)  
junction box

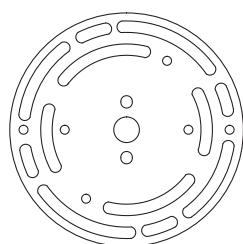

1x

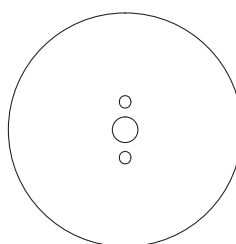

1x

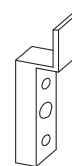

1x



2x

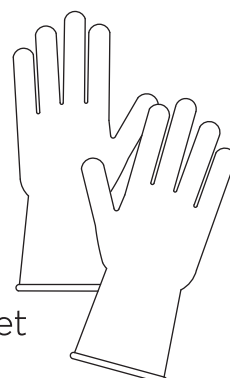

1x set

empyrean  
mounting instructions  
for 120V

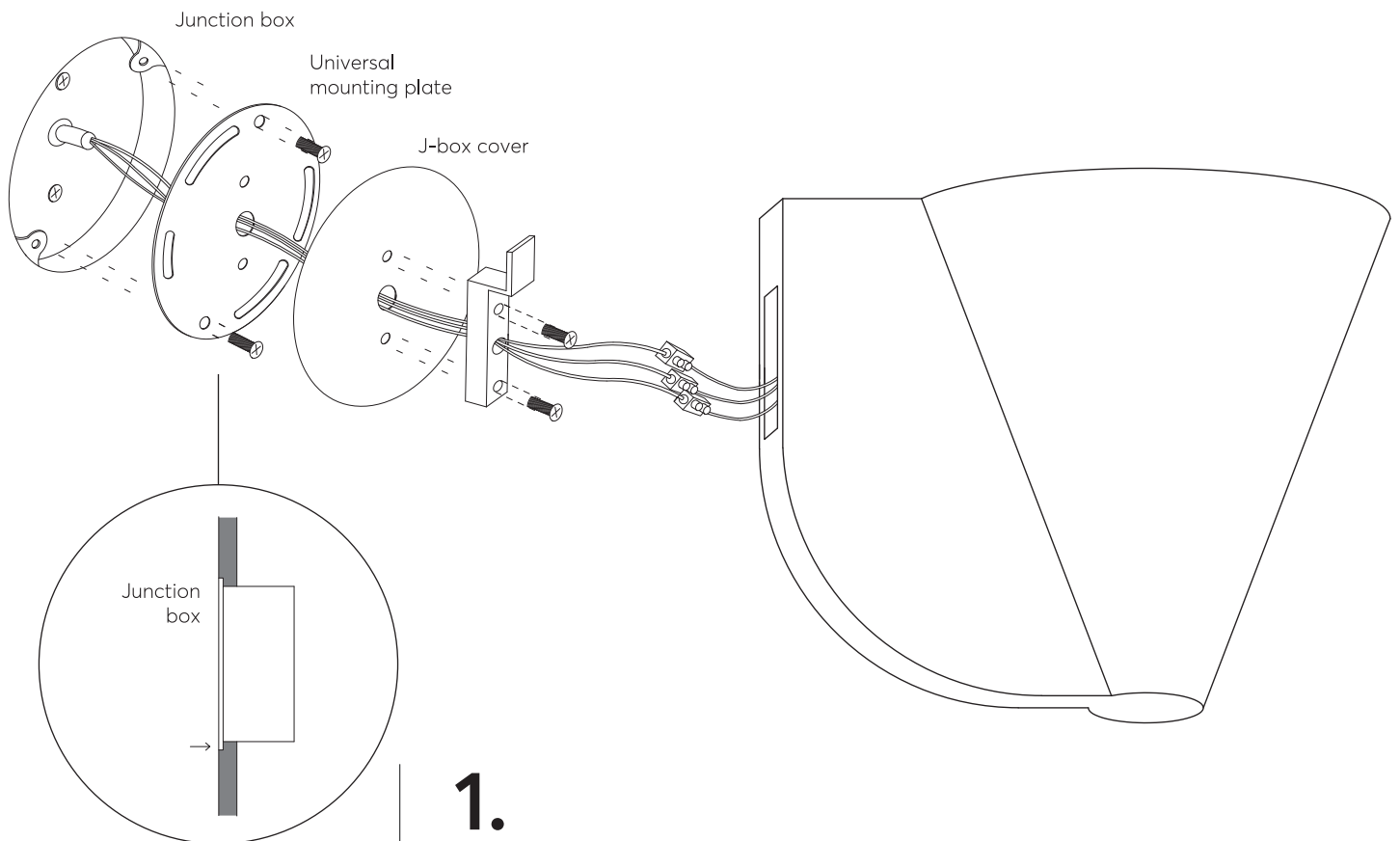

**1.**

Install the junction box, pull the cable out of the central hole and screw the universal mounting plate onto the junction box. For seamless installation please make sure that the external surface of the universal plate is at the same level as the wall.

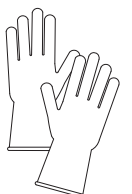

empyrean  
mounting instructions  
for 120V



## 2.

Fasten the fixing bracket on the j-box cover and connect l/n ground at the clamps. Paint the j-box cover the same color as your finish wall and hang the ceramic housing on the bracket. Place an E26/E27 bulb of your choice.

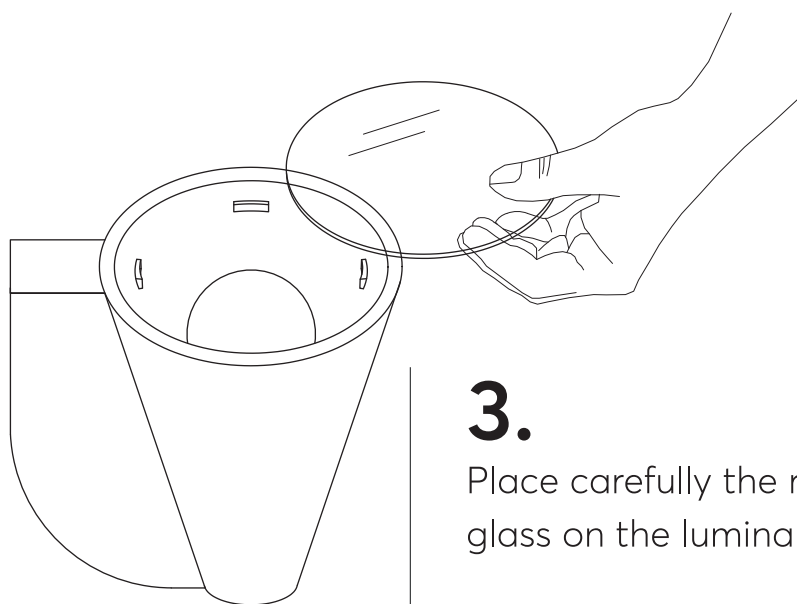
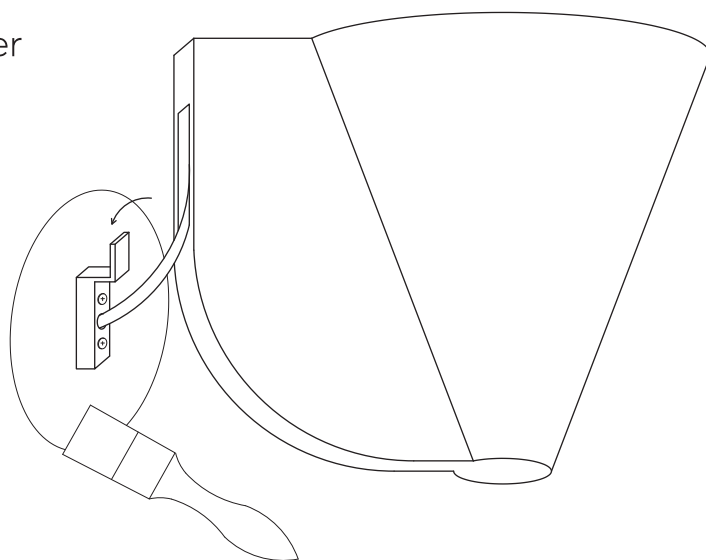

## 3.

Place carefully the round glass on the luminaire.



\*Make sure you use the gloves included in the package





*Mariza Galani, inspired by her Greek roots, creates symbolic lighting elements based on geometry and nature that guide people to experience the sense of wholeness and spiritual uplift. Her goal is to generate lightness and not just light through her creations. All of our fixtures are handcrafted in Greece. Each*

*piece is unique and every effort is made to ensure that the final creation will match the product specifications. Slight differences in dimensions, finishes and colors though may be expected and are considered as part of each fixture's uniqueness. All designs are protected under copyright law.*

---

Mariza Galani  
Armonias 6, Athens 19004  
sales@marizagalani.com

©2022 Mariza Galani.  
All rights reserved.

[www.marizagalani.com](http://www.marizagalani.com)

